

Providence

CUSTOM DENTAL CABINETRY



5
YEAR
WARRANTY
ON ALL PROVIDENCE
CABINETRY



SMART
CABINETS

- **CUSTOM
DESIGNS
AND SIZES
AVAILABLE**

- **BUY DIRECT AND SAVE**

- **YOUR CHOICE OF
700+ COLORS
TO CHOOSE FROM**

- **SOLID SURFACE
COUNTERTOPS
AVAILABLE**



Providence

ESSENTIAL CABINETS

High-quality cabinetry without the customization and options.

SINK MODULE

Standard Features:

- Stainless steel sink
- High pressure laminate colors
- Metal sub base with levelers & removable back panel
- Waste drop
- Handles on doors
- 31.25" w x 37" h x 20" d

\$1049 *Assembled

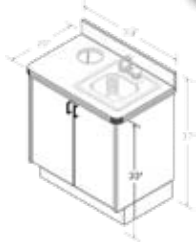

ASSISTANT'S UNIT

Standard Features:

- Stainless steel sink
- High pressure laminate colors
- Metal sub base with levelers & removable back panel
- Handles on doors/drawers
- Waste drop
- 57" w x 37" h x 20" d

\$1360 *Assembled

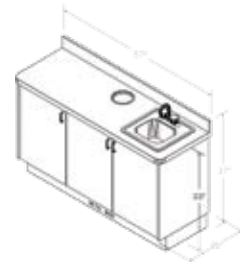

12 O'CLOCK TREATMENT CONSOLE

Standard Features:

- High pressure laminate colors
- Upper storage
- Doctor's storage
- Assistant's side storage
- Metal sub-base with levelers & removable back panel
- Handles on doors/drawers
- Power strip
- Task light
- 42" w x 73" h x 33" d

\$2575 *Assembled

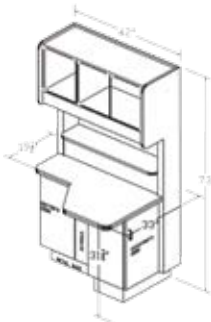

ISLAND UNIT

Standard Features:

- Pass-thru upper storage
- Waste receptacle
- X-ray mounting column
- Stainless steel sink
- High pressure laminate colors
- Metal sub-base with levelers & removable panel
- Handles on door/drawers
- Power strip
- 100" w x 73" h x 20" d (x-ray column is 24" w)

\$3885

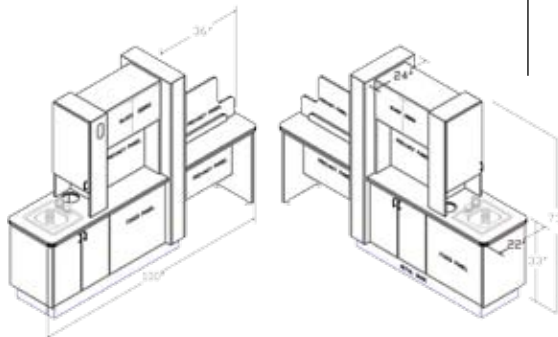

STERILIZATION CABINET

Standard Features:

- Location for dryer
- Task lighting
- Two counter waste drops (Regular/Hazardous)
- High pressure laminate colors
- Stainless steel sink
- Drop down countertop for Ultrasonic
- Metal sub-base with levelers & removable panel
- Power strip
- Handles on doors
- Shelf for sterilizer
- Shelf for Statim
- 96" w x 80" h x 27" d

\$6598



***Assembled. These Cabinets Arrive Completely Assembled.**

Providence

ORTHO/ORAL/PEDO CABINETRY

ORAL SURGERY 48" TREATMENT

- Metal Base
- High pressure laminate
- Stainless steel sink
- Cup dispenser
- Towel dispenser
- Trash drop
- Available 48" or 60"

\$3275



ORTHODONTIC ADULT/CHILD COMBO BRUSHING STATION

- Stainless steel sink
- High pressure laminate colors
- Metal sub base with levelers & removable back panel
- Trash drop
- Handles on doors
- All sides finished
- Available child or adult

\$2115



ORTHODONTICS UTILITY CABINET

- Metal Base
- High pressure laminate
- Stainless steel sink
- Cup dispenser
- Towel dispenser
- Trash drop

\$539



Providence

MOBILE CARTS

ASSISTANT'S "NORTH CAROLINA" MOBILE

(HCES-NORTH CAROLINA)

- 21 1/2" w x 18 3/4" d x 32" h
- Specify requirements for a left or right sliding side-shelf

\$798



ASSISTANT'S "ALABAMA" MOBILE

(HCES-ALABAMA)

- 21 1/2" w x 18 3/4" d x 32" h
- Specify requirements for a front-to-rear or side-to-side slide-top

\$798



DOCTORS MOBILE

(HCES-DOCTOR)

- 21 1/2" w x 18 3/4" d x 32" h
- Seven drawers

\$798



PROVIDENCE ORTHO MOBILE CART

- Writing surface/slide out 7 drawers
- 31 1/4" w x 20 1/4" d x 32 1/2" h
- Delivery system optional
- Monitor and mount optional

\$998

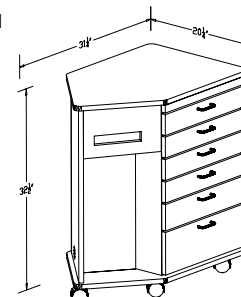

Providence I

CUSTOM CABINETRY

Quality and durability built into a cost-effective design.
Fully customizable.

REAR TREATMENT CONSOLE

Standard features:

- Retractable sliding counter top
- Upper storage
- Task light
- Electrical outlets
- Asst. side storage
- Computer storage
- High pressure laminate
- 44" w x 73" h x 33" d

Optional:

- Solid surface countertop (shown)
- Keyboard tray (shown)

\$3460

*Assembled

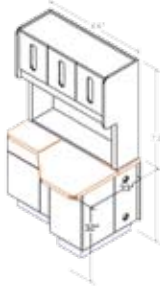
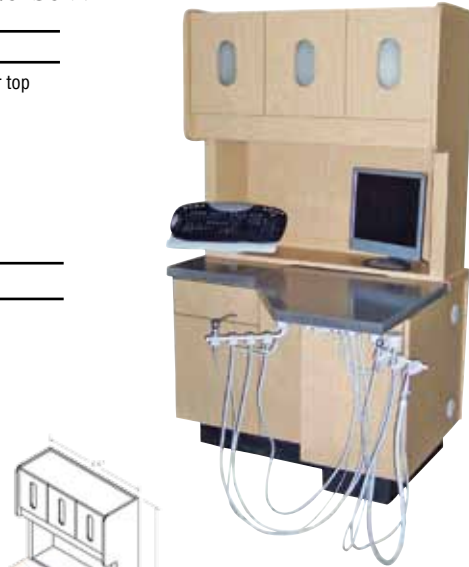

Optional Pass Thru Available
Equipment Not Included

DOCTOR'S UNIT

Standard features:

- 15" square sink
- Storage
- Faucet
- Area for side delivery unit
- High pressure laminate
- 68" w x 37" h x 20" d

Optional:

- Touchless faucet (shown)
- Soap dispenser (shown)

\$1765 *Assembled

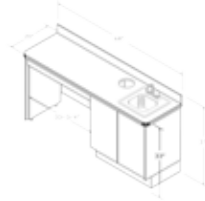

COMBO UNIT

Standard features:

- 15" square sink
- Storage
- Faucet
- 4 drawers
- High pressure laminate
- 36" w x 37" h x 20" d

Optional:

- Touchless faucet (shown)
- Soap dispenser (shown)

\$1635 *Assembled



ASSISTANT'S UNIT

Standard features:

- 15" square sink
- Storage
- Faucet
- 4 drawers
- High pressure laminate
- 57" w x 37" h x 20" d

\$1970 *Assembled

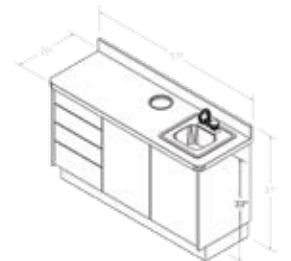

CUSTOM
SIZES
AVAILABLE

We offer complete
new office design
and space planning
services

ISLAND UNIT

Standard features:

- Pass-thru upper storage
- 3 drawers on assistant's side
- 1 drawer on doctor's side
- X-ray mounting column
- Waste receptacle
- Towel dispenser
- High pressure laminate
- 100" w x 73" h x 20" d
(x-ray column is 24" w)

\$4968

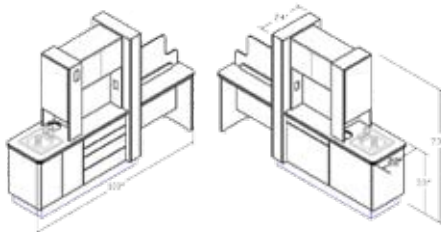

SMART
CABINETS

Providence II

CUSTOM CABINETRY

Our cutting edge line featuring the latest technologies and innovative designs.

Fully customizable.

ISLAND UNIT

Standard features:

- Pass thru upper storage
- 3 drawers on Asst. side
- 1 drawer on Doctor's side
- X-ray mounting column
- Waste Drop
- 15" round sink
- Towel dispenser
- High pressure laminate
- 100" w x 82" h x 24" d

Optional:

- Bi-fold x-ray doors (shown)
- Solid surface countertop (shown)
- Touchless faucet (shown)
- Stainless steel base (shown)
- Lower storage for x-ray/computer (shown)

\$5245



SMART CABINETS

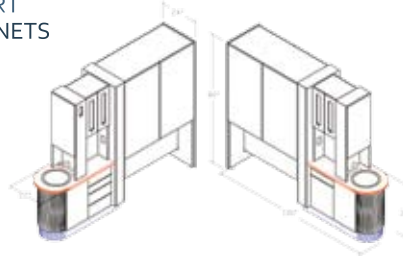

DOCTOR'S UNIT

Standard features:

- 15" round sink
- Waste drop
- Storage
- One drawer
- Faucet
- Area for side deliver unit
- High pressure laminate
- 68" w x 37" h x 20" d

CUSTOM SIZES AVAILABLE

\$2398 *Assembled

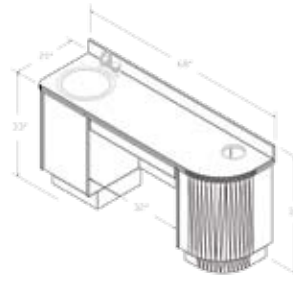

REAR SUPPORT CONSOLE

Standard features:

- 4 way sliding work surface
- Upper storage
- Task light
- Electrical outlet
- Computer storage
- High pressure laminate
- 44" w x 73" h x 32" d

Optional features:

- Solid surface countertop (shown)
- Keyboard tray and monitor mount (shown)
- Stainless steel base (shown)

\$4160 *Assembled

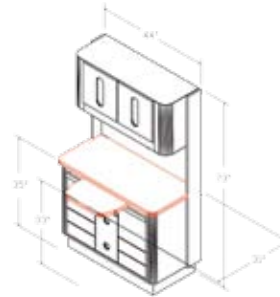

SOLID SURFACE TOPS AVAILABLE ON ALL CABINETS

ASSISTANT'S UNIT

Standard features:

- 15" round sink
- Faucet
- Four drawers
- Waste drop
- Storage
- High pressure laminate
- 72" w x 37" h x 20" d

Options:

- Touchless faucet (shown)
- Stainless steel base (shown)

\$3145 *Assembled

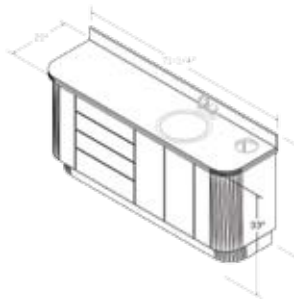

STERILIZATION CABINET

Standard Features:

- Glove dispensers
- Shelving for procedure tubs, setup trays and instrument cassettes
- Red/Blue lights
- Two counter waste drop (regular and hazardous waste)
- Valance lights
- Slide out shelf for sterilizer
- Slide out shelf for Statim
- Recessed cut-out for ultrasonic
- High pressure laminate
- 106" w x 80" h x 27" d

Optional:

- Tapmaster foot pedal (shown)
- Automatic soap dispenser (shown)

\$8678



Equipment Shown In Cabinet Not Included



**700+ COLORS
TO CHOOSE
FROM**

We have 700+ colors to choose from. Please call for more information.

Standard Laminate Colors

See more at - formica.com and wilsonart.com

SOLID COLORS



White
F-949058



Almond
F=920-58

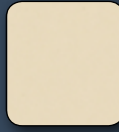

Sand
W/A D331-60



Pebble
W/A D337-60

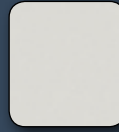

Graystone
F-464-58



Fossil
F-5342-58



Earth
F-5342-58

PATTERNS



Labrador Granite
F-3692-58

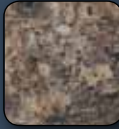

Jamocho Granite
F-7734-58

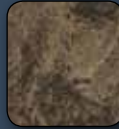

Himalayan Slate
F-3689-77



Grey Pampass
w/a 4168-60



Granite
W/A 4550-60

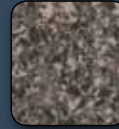

Black Star Granite
W/A 4551-60



Graphite Nebula
W/A 4623-60



Pewter Brush
W/A 4779-60



White Tigris
W/A 4783-60



Santa Celia Light
F-3451-46



Burnished Glaze
F-7704-58

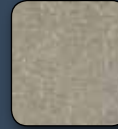

Ashen Ceramic
F-7698-58

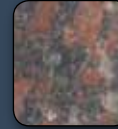

Rosso Granite
F-3917-46

WOODGRAINS



Natural Maple
F-756-58



Natural Birch
F-7481-58



Victorian Mahogany
F-7583-58



Select Cherry
F-7759-58



Blossom Cherrywood
F-758-60



Craft Oak
F-5885-58



Natural Pear
W/A 7061-60

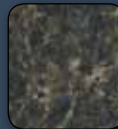

Wild Cherry
W/A 7924-07



Biltmore Cherry
W/A 7924-07



SMART
CABINETS.com

We offer many additional
solid-surface colors. Please
call for more information or visit

dovae.com

SOLID SURFACE COLORS



Ivory
DOVEA 1101B



Bone
DOVEA 1102B



Ocala Stone
DOVEA 1646B



Pecos Stone
DOVEA 1644B

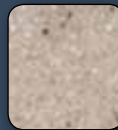

Spice
DOVEA 1216A



Casa Blanca
DOVEA 7806A

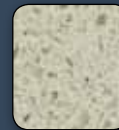

Galveston
EOS (3CM)

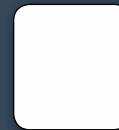

Glacier
EOS (3CM)

FOR FULL LINE OF STANDARD CABINETY VISIT OUR WEBSITE



SMART
CABINETS

707 N Scott Ave
PO Box 8326
Wichita Falls, TX 76307
1-866-562-7345
Tel: 940-766-5209
Fax: 940-767-6383
E-mail: sales@smartcabinets.com
www.SmartCabinets.com